



PARS SWITCH

PARS SWITCH

Sf6 CIRCUIT BREAKER LTB D1/B

With Auto-Puffer System for outdoor installation

- Rated voltage :72.5 - 170 kV
- Rated current :3150 A
- Rated breaking current : 40 KA
- Rated frequencies: 50 and 60 Hz

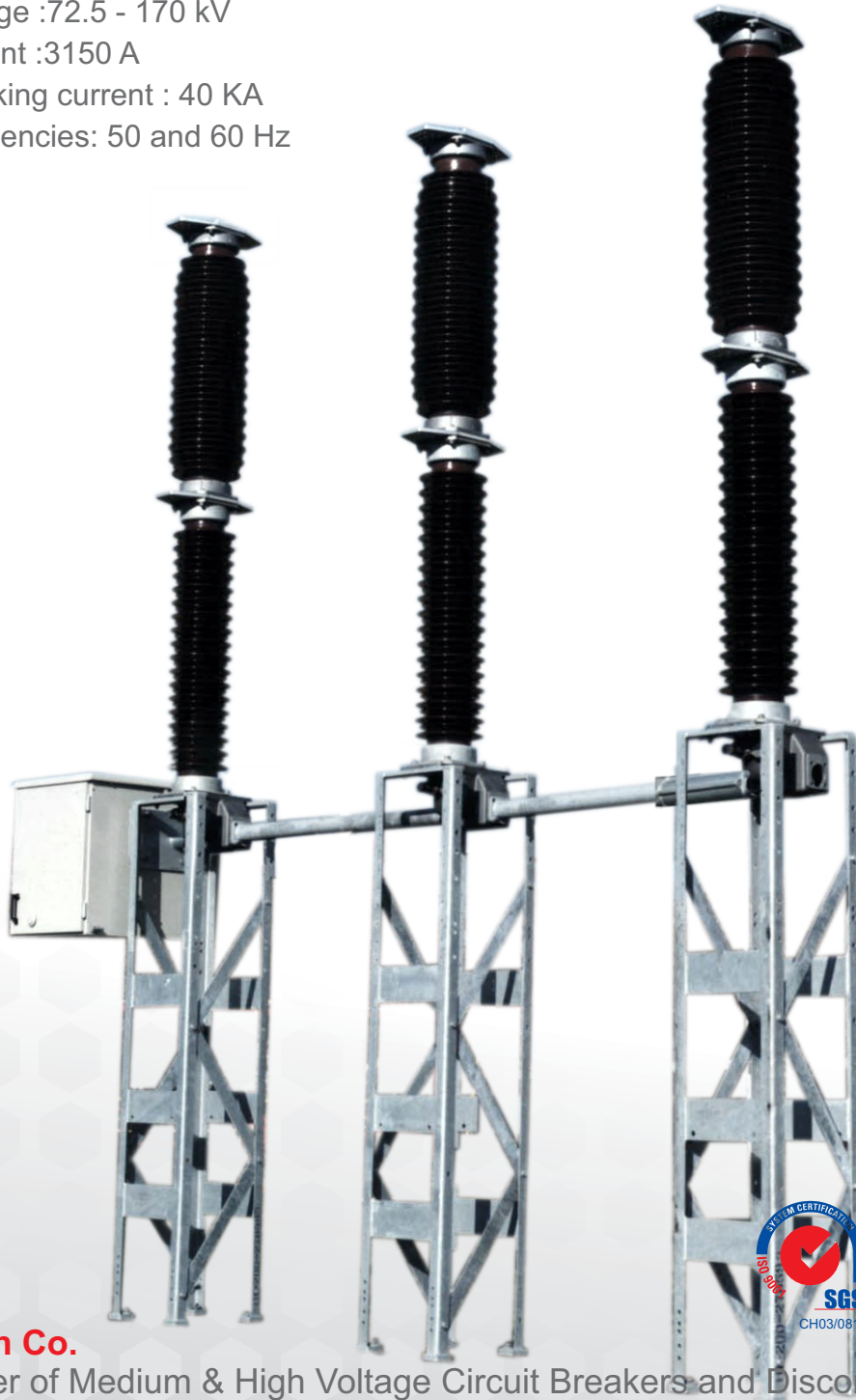

Pars Switch Co.

Manufacturer of Medium & High Voltage Circuit Breakers and Disconnecting Switches



General:

the LTB D1/ B is a live tank SF₆, auto puffer circuit breaker designed for 72.5-170 kV and with a rated breaking current 40 KA, the energy required for interrupting short circuit currents is partly taken from the arc itself, thereby reducing the energy required from the operating mechanism to less than 50 % compared with a conventional SF₆ puffer-type circuit breaker.

Lower operating energy inherently reduces mechanical stresses, on the circuit breaker itself as well as on the foundation, and increases circuit breaker reliability.

Main features and advantages:

the LTB circuit-breaker, which satisfies the highest demands and is based on latest developments in arc research, provides the following advantages:

- Restrike-free interruption of capacitive currents on account of high inherent dielectric strength of the SF₆ gas and optimized contact movement.
- Low overvoltages when switching inductive currents as a result of optimum quenching at current zero.
- High dielectric strength even at atmospheric SF₆ pressure, due to wide contact gap.
- Low noise level, hence suitable for installation in residential areas.
- Designed for extreme environmental conditions.
- High seismic withstand capability due to optimized pole and structure design.
- Superior reliability due to :
 - ◆ Low operating forces.
 - ◆ Separate arcing contacts.
 - ◆ Double O-rings in all seals which give low leakage rate.
 - ◆ Reliable components.
- Easy installation and commissioning.
- Maintenance free under normal service conditions.

The LTB circuit-breaker uses a simple and reliable energy storage in a spring operating mechanism type BLK 222. it offers an optimized design for three poles or single pole operation.

One BLK is used for three-pole operation, and three BLKs for single pole operation of the circuit-breaker.

The LTB breaker complies with national standards (IS). International standards (IEC) and other major standards like ANSI, DIN etc.

DESIGN:

The three poles of the circuit-breaker are mounted on individual supporting structures. In the case of three-pole operation, the breaker poles are linked to each other and to the mechanism by means of pull rods. The opening spring is attached to one end of the pull rod and the operating mechanism to the other end.

Each circuit-breaker pole constitutes a hermetically sealed unit, which includes the breaking unit, the porcelain supporting insulator and the mechanism housing. The breaker poles are filled with gas to the following pressure (at +20°C) :

LTB for 72.5 kV:

- 0.5 MPa (abs.) SF₆ gas for operation down to -40°C.
- 0.5 MPa (abs.) mixed gas for operation down to -50°C.

LTB for 145 kV:

- 0.5 MPa (abs.) SF₆ gas for operation down to -40°C.
- 0.5 MPa (abs.) mixed gas for operation down to -50°C.

LTB for 170 kV:

- 0.7 MPa (abs.) SF₆ gas for operation down to -30°C.
- 0.7 MPa (abs.) mixed gas for operation down to -40°C.

The operational reliability and the service life of an SF₆ circuit-breaker is very much dependent on its ability to maintain the pressure of the SF₆ gas and to neutralize the effects of moisture and decomposition products in the gas.

- Double O-rings of nitrile rubber are used for sealing purposes with excellent results.
- Each breaking unit is provided with an absorber. The absorption agent absorbs the moisture and the gaseous decomposition products from the interruption process.
- Since the interrupting capability is dependent on the density of the SF₆ gas, the LTB circuit-breaker is provided with a density monitor common for the three poles.

The density monitor consists of temperature independent pressure switch. Temperature-dependent pressure variation in the breaker poles will be compensated by a hermetically sealed reference gas volume and, for this reason, an alarm signal is issued only if the pressure drops due to leakage.

Technical data

Values complying with IEC 62271-100 (50 Hz) and ANSI C37(60 Hz)

Size LTB D1/ B

			72.5	123	145	170
Rated voltage	IEC	kV	72.5	123	145	170
	ANSI	kV		121	145	169
Power frequency withstand voltage						
1 min dry	IEC	kV	140	230	275	325
1 min wet	IEC	kV	140	230	275	325
1 min dry	ANSI	kV		260	310	365
10 sec.wet	ANSI	kV		230	275	315
Lightning impulse withstand 'voltage (LIWL)	IEC	kV	325	550	650	750
Full wave 1.2/50 μ s	ANSI	kV		550	650	750
Chopped wave 2 μ s	ANSI	kV		710	838	968
Chopped wave 3 μ s	ANSI	kV		632	748	862
Creepage distance to earth 1) 2)	mm		2660	4015	4015	5045
Creepage distance across break 1) 2)	mm		4600	3800	3800	4887
Rated normal current	A				3150	
Rated breaking current	KA				40	
First pole to clear factor					1.5	
Making current / peak	KA				100	
Duration of short circuit	s				3	
Closing time	ms				45	
Opening time	ms				30	
Total break time	ms				55	
Dead time	ms				300	
Rated reclosing time	ms				300+55	
Rated operated sequence	IEC				O-0.3 sec-CO-3 min-CO	
	ANSI				CO -15 sec - CO	

1) Other values on request

2) Tolerance according to IEC 233

Spring operating mechanism Type BLK 222:

The need of electrical energy without interruption is becoming more and more important. To meet this requirement, the demand on reliability of each individual component is increasing.

The circuit-breaker constitutes the last link in the chain of different apparatus which form part of the protection equipment for a power supply system. Within a few milliseconds the operating mechanism has to supply the energy which will transform the circuit-breaker from a perfect conductor to a perfect insulator.

A failure in the operating mechanism constitutes a failure in the total breaking operation. The operating mechanism plays a major role on the reliability of the circuit-breaker and thereby also of the total power supply system.

In an international investigation it was shown that 80 percent of all failures in high voltage circuit-breakers were due to mechanical reasons. Therefore, to achieve highest operational reliability, the mechanical design should be as simple and robust as possible. In light of this a new motor charged spiral spring operating mechanism of type BLK 222 is introduced. The design is characterized by a reduced

minimum number of mechanical components in a neat and compact enclosure.

At low (-55° C) and high (+70°C) ambient temperatures the springs and latches are not influenced by the extreme temperature these ensures a high degree of total reliability for the circuit-breaker and a minimal need of maintenance. The spiral spring operating mechanism of type BLK 222 is designed with a minimum number of components. See figure 3. The power unit is characterized by the following robust main components:

- The closing spiral spring which directly is driving the lever of the circuit-breaker without any intermediate cam disc, link or shaft.
- The spiral spring is charged by a small universal series motor.
- All power components are carried on one main shaft carried by the structure.
- The trip and closing latches are identical, fast acting and vibration proof.
- A dashpot is included to retard the motion of the contact system in the end position.

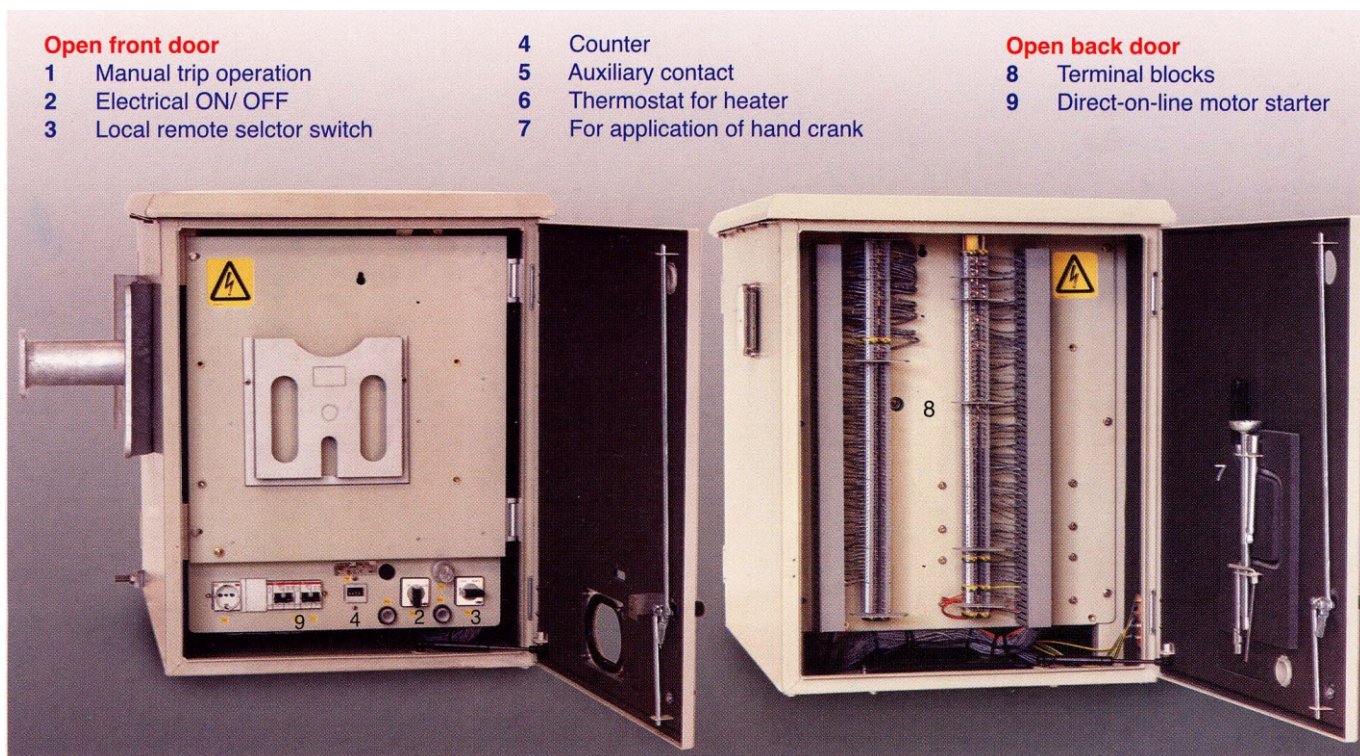

Operation:

The circuit-breaker is operated by a trip spring (A) located in the base frame of the breaker. The closing spring (6) is located in the motor charged spring operating mechanism. The closing spring is spiral wound and charged by means of:

1. Normal service position:

The normal position of the circuit-breaker is when the contacts are closed and the trip spring and the closing springs are charged. The breaker is ready to interrupt on trip command and also ready to complete a full auto reclosing cycle O-O.3s-CO.

The auxiliary equipment is characterized by the following main components:

- All electrical wiring is taken to the terminal blocks.
- Robust auxiliary contacts.
- Robust limit switches.
- The control panel is easily accessible behind the front door.
- Terminal blocks are easily accessible behind the back door.
- State of tension of the closing spring is displayed.

The housing of the spring operating mechanism is

characterized by the following features :

- Corrosion resistant housing.
- Front and back doors equipped with door stop and door lockable by pad locks.
- Insulated doors and walls for low energy consumption and low noise level.

a universal motor (8) over a worm drive (7). After releasing the closing latch (4) the closing energy during closing is transmitted via the driver (2) to the circuit-breaker contact and the trip spring.

The circuit-breaker is kept in the closed position by trip latch (1).

2. Tripping operation:

To trip the breaker, the trip latch (1) is released by the tripping coil and the trip spring (A) of the breaker carries out the operation.

The motion of the contact system is retarded by a dashpot. With a spring operated breaker the tripping operation is extremely reliable as the operation is only dependent on the functioning of the trip latch and the trip spring.

Fig.4

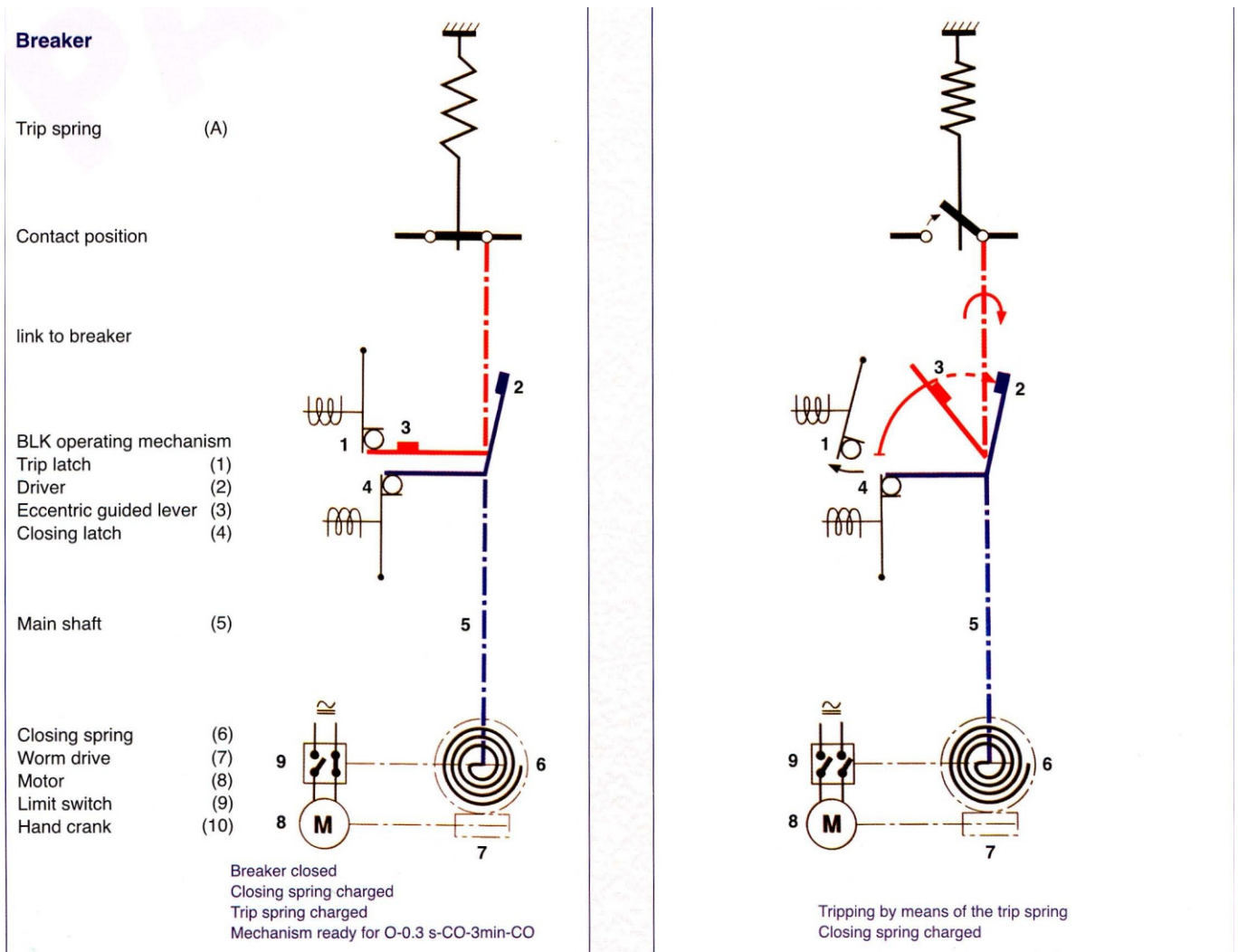

- A Trip spring
- 1 Trip latch and magnet
- 2 Driver
- 3 Eccentric guided lever

- 4 Closing latch and magnet
- 5 Main shaft
- 6 Closing spring
- 7 Worm drive

- 8 Universal motor
- 9 Limit switch
- 10 Hand crank
- 11 Dashpot

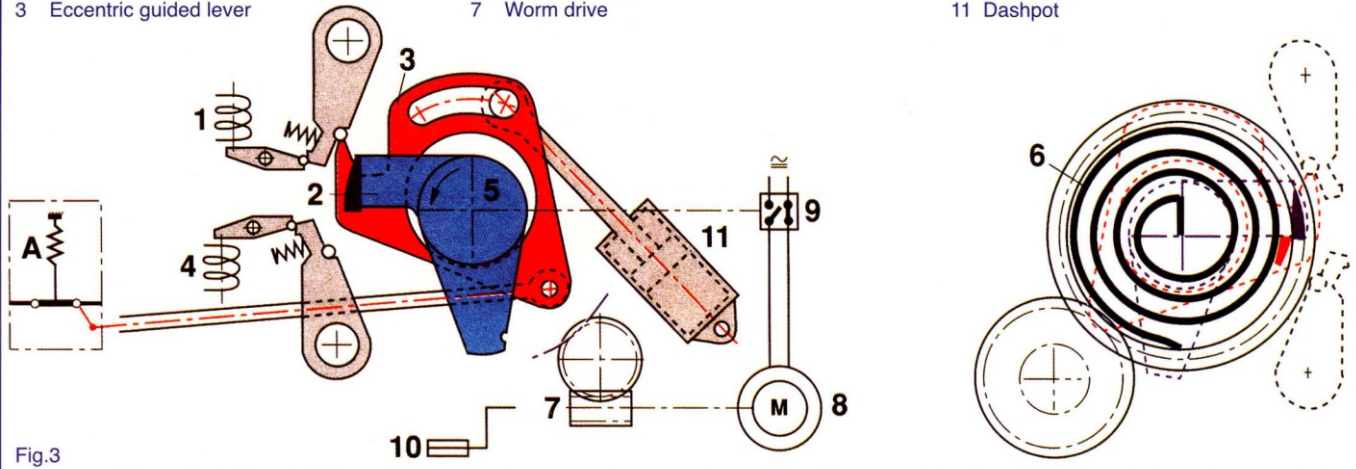

Fig.3

3. Closing operation:

Releasing of the closing latch(4)means an immediate response to close the circuit-breaker.The driver lever(2)brings the eccentric guided closing lever(3)to the closed position .At the same time the trip spring(A)is charged. At the end of the stroke the closing lever(3)connected to the breaker is hooked up by the trip latch(1) in the closed position. Due the eccentric guided lever(3)the driver lever (2)is declutched and continues to the resting position.

4. Charging of the closing spring:

The circuit-breaker has been closed. The motor circuit is closed by limit switch(9).The motor(8)starts and charge the closing spring(6)as the main shaft(5)and the driver(2)are hooked up by closing latch(4)When the closing spring is fully charged the limit switch will open the motor circuit.In case of an emergency,the spring can be charged by means of the hand crank(10) ,enclosed in the cubicle.

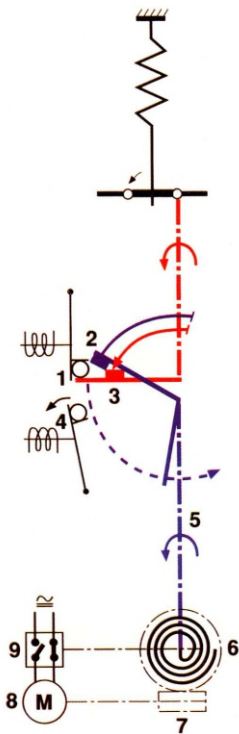

Closing by means of closing spring

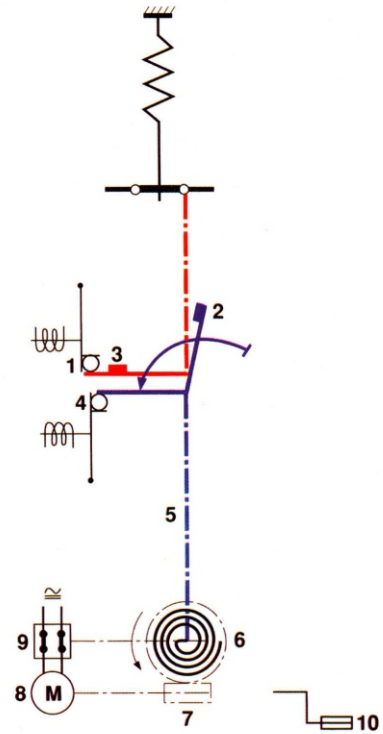

Breaker closed
Trip spring charged

Electrical functions:

The basic functions of the electrical components of the operating mechanism are shown in the basic circuit diagram (Fig.5)

Closing circuit

The closing coil(Y3)can be activated electrically by means of local or remote control. Once the breaker is closed the closing coil(Y3)supply circuit is interrupted via auxiliary contact(BG).

Interlocking at close

Auxiliary contact(BG)ensures that the closing signal is only transmitted when the breaker is fully open. The gas density monitor contact controls the auxiliary relay(K9) and blocks the switching command when the SF6 pressure is too low .Anti pumping relay(K3)cancels the persistent closing signal after successful completion of the closing operation.

Tripping circuits

The breaker is equipped with two tripping coils (Y1)and(Y2)each independent from the other. These can be manually activated via the manual handle on the trip latch package or electrically by means of local or remote control. When the breaker is in the open position, auxiliary contacts (BG) interrupt the supply circuit to the tripping coil (Y1),(Y2).

Interlocking at trip:

Auxiliary contacts (BG)ensure that the tripping coil (Y1),(Y2) can only be energized when the breaker is closed. In the event of the SF6 gas density being too low, the tripping and closing circuit will be interrupted by the gas supervision relays.

Monitoring and signalling:

In order to monitor the operating condition of the SF6 gas and the operating mechanism,electrical signals are employed for remote indication :

- SF6 gas density too low
- Replenishment of SF6 gas recommended
- Protection switch ' Motor supply ' tripped
- Spring failure alarm

Heating circuit:

The control cubicle is fitted with a continuous heater to avoid water condensation. For low temperature operation an extra thermostatically controlled heater is supplied.

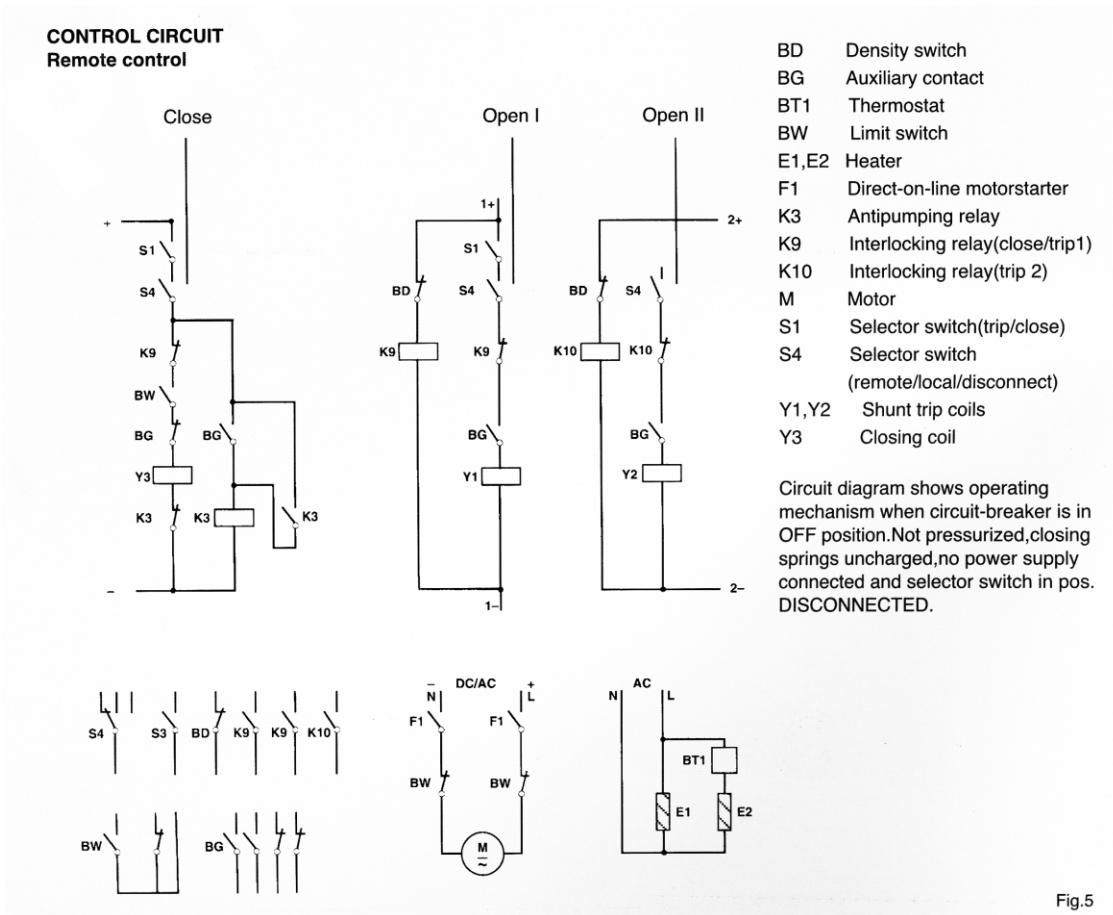

Fig.5

Motor

Universal series motor for voltage 110 - 125 V or 220 - 250 V , AC or DC		
	Starting	Normal
Rated	current	current
Voltage	Instantaneous	at d.c
V	approx.A	approx.A
220	18	6
110	36	12

Spring charging time 10 - 15 s.

Operating coils

	Rated voltage	Power consumption
Operating coil	V , DC	approx.W
Closing coil	110 - 125,220 - 250	200
Opening coil	110 - 125,220 - 250	200

Voltage operating range for motor and operating coils meet the requirements in IEC 62271 - 100 and ANSI C 37.

Auxiliary contacts

			Breaking current	
Rated voltage V	Rated current A	Closing current A	DC L/R =40 ms A	AC cos φ =0.95 A
110	25	20	4	25
220	25	10	2	25

The operating mechanism normally includes 7 N/O and 9 N/C spare auxiliary contacts.

Testing:

The spring operating mechanism has passed type testing according to IEC 62271-100 and ANSI C 37.

Mechanical life test is performed up 10000 operations.

Before delivery each operating mechanism has to pass rigorous routine testing with related poles.

For each breaker a routine test report is issued showing the actual test result.

Transport and erection:

The LTB circuit-breaker poles are transported as complete units filled with SF6 gas to a slight overpressure.As the circuit-breaker is assembled and routine tested in the factory the erection work at site is very simple and can easily be done in one day.

Filling of SF6 gas to specified overpressure can be facilitated by using the following pressurising equipments .

One special control valve,for connection to the SF6 gas bottle,and a hose with connector .

A complementary control valve for connection to an N2,gas bottle (for mixed gas filling).

Heating elements

	Power consumptions	
	Continuously	Thermostatically
Rated voltage	connected	controlled
V,AC	W	W
210-230	70	140
Power frequency test,one minute,50 Hz		
Auxiliary circuits	2.0 kV	
Motor	1.5 kV	

Degree of protection as per IEC 529 IP 55

Terminal blocks Type Ph6nix UK 10
Connectable cable are a 2 x 6 mm²

Cable - entry flange Size FL33
102x306 mm

Earthing clamp For conductor with max 13 mm diameter

Optional versions for circuit breaker:

- Special phase-distance .
- Bursting disc .

Shipping

Preliminary shipping data for 3-pole circuit-breakers type LTB D1/B, complete with stands and operating mechanism (S).

Breaker size	Principle Of operation	Shipping data			
		Number Of cases	Total Volume m ³	Total Gross weight Kgs	Total Net weight Kgs
LTB 72.5	1	3	5	1591	1370
LTB 123 & 145	3	3	6.1	1800	1420
LTB 123 & 145	1	5	8.17	2330	1830
LTB 170	3	3	6.64	2000	1524
LTB 170	1	5	8.72	2530	1934

Dimensions:

LTB D1/ B 123 - 170 kV,
3- pole operation

As standard specifications and designs change from time to time
please ask for confirmation of the information given in this publication

LTB D1/ B 123 - 170 kV,
1- pole operation

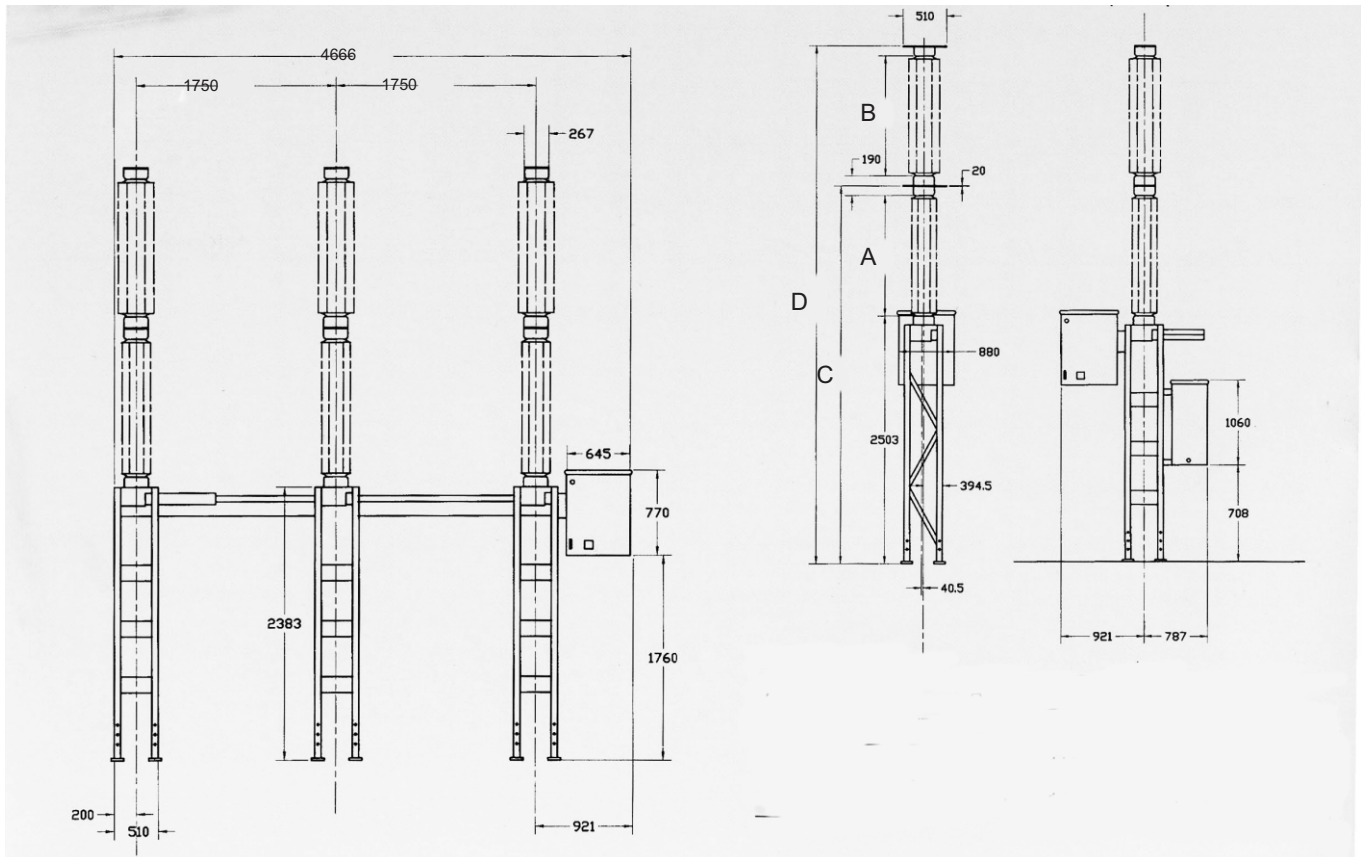

Dimensions in mm

Circuit-breaker	A	B	C	D
Type LTB 123 D1/B	1220	1164	3833	5197
Type LTB 145 D1/B	1220	1164	3833	5197
Type LTB 170 D1/B	1520	1475	4133	5808

Dimensions:

LTB D1/ B 72.5 kV,
3- pole operation

Plates for LTB-D
Refer to drawing No. 88230177

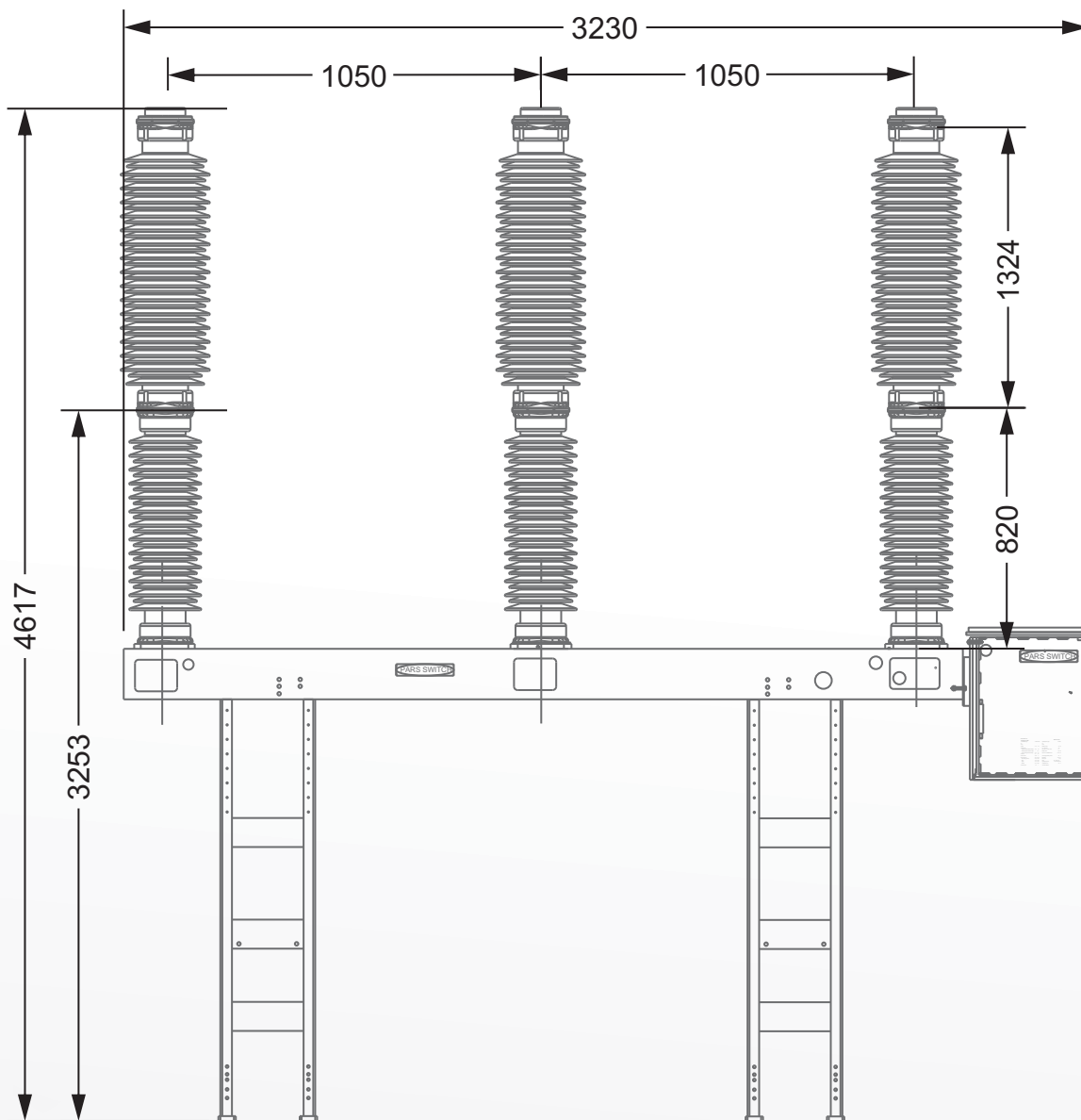

Shipping data

مَبسان

(مهندسی بازرگانی سیستم‌های انتقال نیرو)

تامین و فروش تجهیزات 20Kv (دژنکتور، تابلو، کابل، ترانس) و ...

ایمیل: mabsanniruo@gmail.com

تلفن: 021-33999637-8

همراه: 0912-1127656

سایت: mabsanpower.com

فکس: 021-33999802

تهران، لاله زار جنوبی، کوچه بوشهری، مجتمع تجاری تهران الکتریک، طبقه دوم، واحد ۳۱۱